

# ***Sniffer***

## *IrDA-Control Packet Sniffer Kit*

### **Users' Manual**

Version 1.02

October 07, 1998

**SHARP CORPORATION**

**(INFORMATION DISCLAIMER)**

This document is a "Users' Manual" for the Sharp IrDA-Control Packet Sniffer Kit. Copying the whole contents or any part of contents of this document is strictly prohibited unless otherwise approved by written permission of Sharp Corporation. All information in this document is applicable for reference purposes only, and Sharp holds the right to change or alter this information or prices of specified components at any time without notice.

In the absence of confirmation by device Specification Sheets, SHARP takes no responsibility for any defects that occur in equipment using any of SHARP's device, shown in catalogues, data books, Preliminary Information, etc. Contact SHARP, or SHARP local representatives in order to obtain the latest version of the device Specification Sheets before using any SHARP's devices.

**LIFE SUPPORT POLICY**

SHARP components should not be used in medical devices with life support functions or in safety equipment (or similar applications where component failure may result in loss of life or physical harm) without the written approval of an officer of the SHARP Corporation.

SHARP reserves the right to make changes in specifications at any time and without notice. SHARP does not assume any responsibility for the use of any circuitry described; no circuit patent licenses are implied.

**Table Of Contents**

**1. INTRODUCTION ..... 4**

**2. BEFORE USING SNIFFER KIT ..... 4**

2.1 ENCLOSED TOOLS..... 4

2.2 SNIFFER KIT SYSTEM SET UP..... 4

2.3 SNIFFER PROGRAM INSTALLATION ..... 5

2.4 SNIFFER BOARD SET UP ..... 5

2.5 PC PRINTER PORT (PARALLEL PORT) CONFIGURATION..... 6

**3. BASIC OPERATION OF SNIFFER PROGRAM..... 6**

3.1 EXECUTING SOFTWARE ..... 6

3.2 SNIFFER PROGRAM OPERATION DISPLAY ..... 7

3.3 QUITTING SNIFFER PROGRAM..... 7

**4. EVALUATION OF PACKET DATA ..... 8**

4.1 PACKET DATA ANALYSIS..... 8

4.2 EXAMPLE OF PACKET DATA ..... 9

**5. TROUBLE SHOOTING ..... 9**

**6. APPENDIX. PACKET DATA EXAMPLE ..... 10**

(EXAMPLE 1 : ENUMERATION) ..... 10

(EXAMPLE 2 : USB-ENUM) ..... 12

(EXAMPLE 3 : DATA INPUT) ..... 15

**Record Of Modification**

Version	Date of Issue	Comments
0.1	June 3rd, 1998	First Edition (for Public Release)
1.02	October 7th,1998	Modification and addition to the First Edition

## 1. Introduction

The Sharp IrDA-Control Packet Sniffer Kit (Sniffer Kit) is a development support tool to help users develop IrDA-Control specification compliant peripheral devices. Because the Sharp Sniffer Kit includes a sniffer board and sniffer program (for PC), users can analyze the packets of IrDA-Control infrared communication.

Figure 1.1 shows the evaluation system structure with Sharp Sniffer Kit. This system enables users to evaluate and analyze the infrared signal packet data, where the data transaction occurs between the Host device and the Peripheral device.

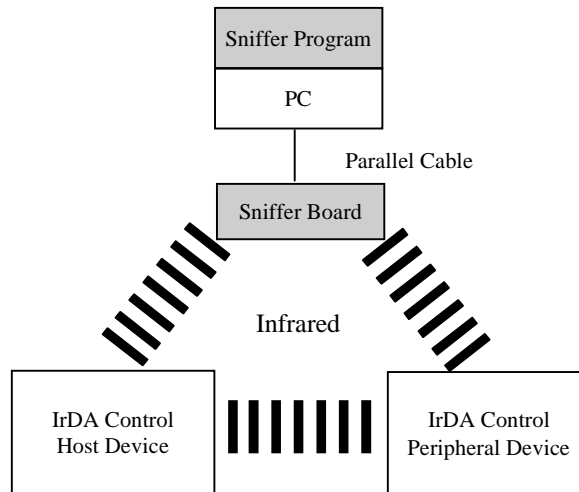

Figure 1.1 Evaluation System

## 2. Before Using Sniffer Kit

### 2.1 Enclosed Tools

The Sharp Sniffer Kit contains following tools in its package:

- **Sniffer Board** Evaluation board. A PWB, on which an infrared transceiver, and IrDA-Control IC are mounted, together with parallel interface circuit for PC connection is designed.
- **Parallel Cable**
- **Power Supply Adapter**
- **Floppy Disk** This FD provides PC sniffer program (sniffer.exe) that runs on PC/AT compatible.

### 2.2 Sniffer Kit System Set Up

The Sharp Sniffer Kit system should be set up by following the steps described below:

- 1). Install Sniffer program on the PC prepared for the evaluation.
- 2). Connect the Sniffer Board and PC with the enclosed parallel cable.
- 3). Configure the PC Printer (parallel) port.
- 4). Supply power to the Sniffer Board

#### **(IMPORTANT NOTICE)**

In case of using external power supply, the rated power supply on the enclosed AC adapter must be applied to the Sniffer board. ([INPUT] AC 120 V, 50/60 Hz, 18 W [OUTPUT] DC 6 V, 2 A)

Details of each step described above are provided in following chapters, and set up must be complete by the instructions provided therein.

### 2.3 Sniffer Program Installation

Sniffer program can only be executed in DOS mode at this moment. The software can be installed on any desired directory (folder). Please create the directory (folder) and copy "sniffer.exe" in FD that comes with the Sniffer Kit. Following is an example of installing Sniffer program to C:\SNIFFER (suppose FD drive is assigned to A:);

```
MKDIR C:\SNIFFER  
COPY A:\SNIFFER.EXE C:\SNIFFER
```

(NOTE)

PC for the Sniffer Kits must meet following requirements:

- Hardware: PC/AT Compatible
- Software: MS-DOS (DOS/V or Windows 95 DOS mode)

### 2.4 Sniffer Board Set up

Figure 2.1 shows rough drawing of the Sniffer Board that comes in the Sniffer Kit. Referring to the figure shown below, following set up must be completed:

- One side of the enclosed parallel cable must be connected to CN1 of the Sniffer Board, and the other end to the prepared PC. (Any side can be connected to PC or the Sniffer Board.) In case that the enclosed parallel cable will not be used, a DB25 (25 pin - 25 pin, male to male) straight cable must be used with full connection.
- CN2 must be connected to the enclosed power supply adapter.

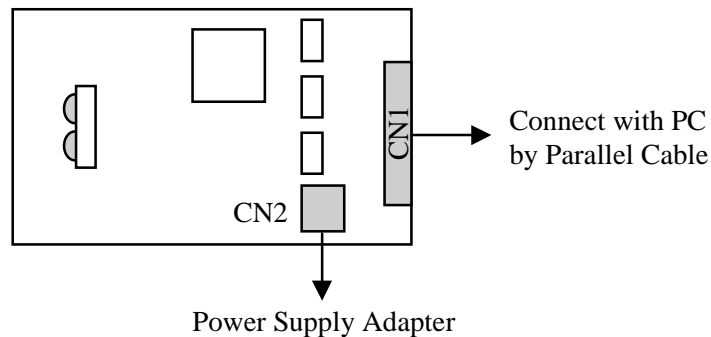

Figure 2.1 Core Board Rough Drawing

## 2.5 PC Printer Port (Parallel Port) Configuration

The printer port of the PC used with the Sniffer Kit must be selected to one of the combinations provided in table 2.1. (For the port configuration, the procedure provided in the PC BIOS must be used.) It is recommended to select “Port 2” printer port unless otherwise the system has some specific problems:

The Port Mode must also be configured to the Bi-directional mode (PS/2 compatible mode), following the setup instructions provided by PC BIOS. Boot the PC by DOS mode, which an instruction for Windows OS Environment is provided below.

Note that the Port number does not directly correspond to the U.S. standard “LPT” port convention used in the United States. The standard default in the U.S. is port 2, which corresponds to LPT1.

### - Windows OS Environment:

DOS mode of Windows 95 will be used. Press F8 when booting the PC, and select the Windows 95 boot menu when displayed on the PC. Select “Command Prompt Only”, and continue. Change directory to the location where the Sniffer execution file is installed, and execute the program.

Note that this software will not run in DOS mode from the Windows 95 start menu, or Windows DOS window.

Port	Port Address	Interrupt	U.S. Printer Port
Port 1	3BCh	IRQ7	
Port 2	378h	IRQ7	LPT1
Port 3	278h	IRQ5	LPT2

Table 2.1 Parallel Port Configuration

## 3. Basic Operation of Sniffer Program

### 3.1 Executing Software

The Sniffer software runs in DOS mode. The execution file name for this software is “SNIFFER.EXE”. This program can also be operated with different configurations of printer port. Adding the following option when executing the Sniffer program can change the printer port configuration:

Option : -pN (N represents # of port, 1 to 3 can be applicable. Default is 2)

e.g.) Connecting Sniffer board with printer port 1:

Command : sniffer -p1

In addition, the monitored packet data will be displayed to the standard output of PC. However, if one wishes to output the monitored packet data to a file, file name should be added following the Sniffer command and executed. Names for the data file can be any name, so that overwriting the file can be avoided.

e.g.) Output the packets to be monitored to the file, named “ir\_packet.dat”:

Command : sniffer ir\_packet.dat

### 3.2 Sniffer Program Operation Display

When Sniffer program is correctly executed the operation console such like Figure 3.1 will be displayed on the PC.

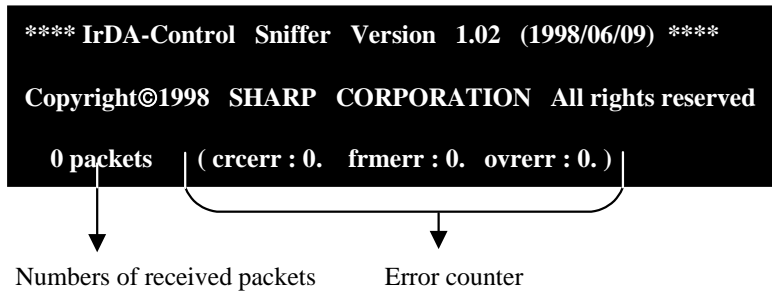

Figure 3.1 Sniffer Program Operation Display

Descriptions of error counters are provided in the table 3.1 shown below:

Display	Error Description
crcerr	Numbers of packets had errors at CRC check
frmerr	Numbers of packets had frame errors
ovrerr	Numbers of packets had receipt over-run

Table 3.1 Descriptions of Error Counter

### 3.3 Quitting Sniffer Program

To quit (exit) the Sniffer program, press [q]. Note that the Sniffer program will automatically closed when the receiving memory became full. To shutdown the Sniffer program, press [Ctrl] + [C]. When you shutdown the program, all received data will be eliminated.

## 4. Evaluation of Packet Data

### 4.1 Packet Data Analysis

The monitored packet data will be outputted in the format shown in Figure 4.1.

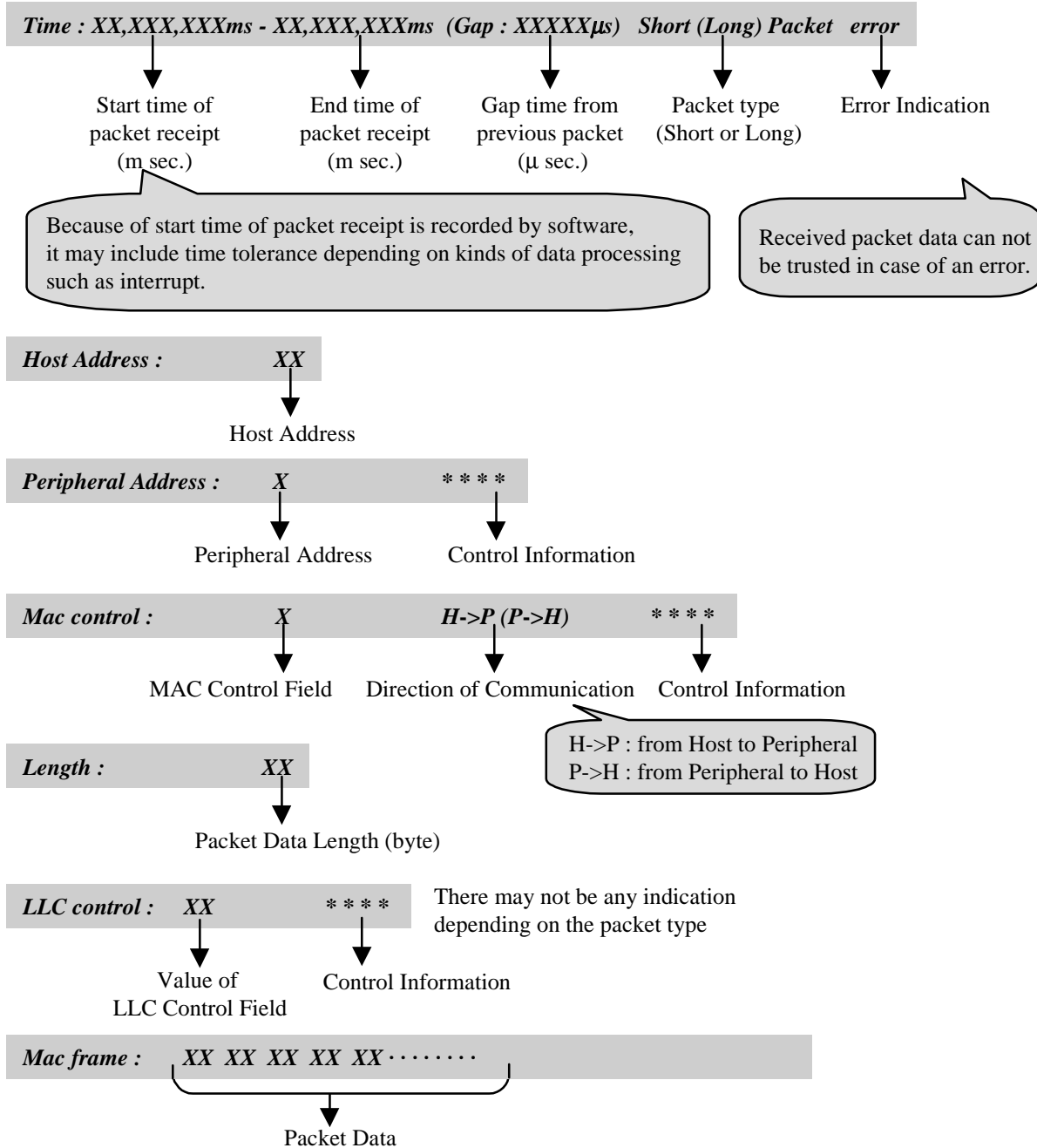

Figure 4.1 Packet Data Format



## 4.2 Example of Packet Data

Figure 4.2 shows a monitoring example of the packet transmitted/received between the Host and the Peripheral device.

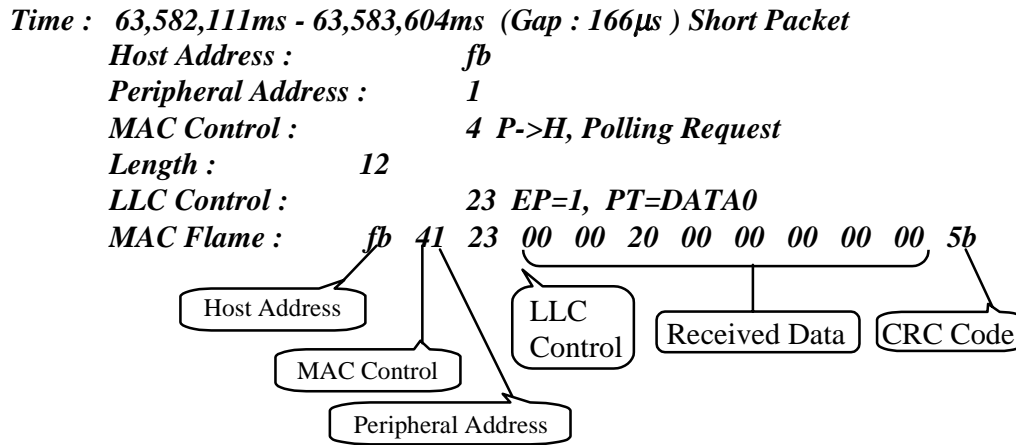

Figure 4.2 Packet Data Example

## 5. Trouble Shooting

The following information can be referenced for trouble shooting. Please read through the following information before contacting any of Sharp local sales for malfunctions of the Sniffer board:

- ◆ “No Memory for...” error message appeared in executing the Sniffer kit;

The recommended memory size must be allocated to the conventional area by not loading other drivers. This Sniffer program requires conventional memory size of as much as 450Kbytes.

- ◆ “Hardware Error!!!” error message appeared in executing the Sniffer kit; Please check your system and see whether your case would fit to the following:

(1) Power supply is not applied to the Sniffer board:

➔ Please connect the enclosed AC adapter to CN2 and apply appropriate power supply.

(2) PC BIOS is not appropriately configured:

➔ Please configure the port mode to bi-directional (bi-directional) mode.

➔ Please re-configure the printer port configuration (port address, IRQ) by referring to the Table 2.1 provided in Section 2.5.

## 6. Appendix: Packet Data Example

In this section, using the examples provides the explanation on actual packet transactions between the Host device and the Peripheral device. Example 1 is for Enumeration sequence, Example 2 for USB-Enumeration sequence, and Example 3 for the Sniffer log at data input/output.

### (Example 1: Enumeration)

Peripheral control information at the Enumeration sequence can be briefly explained as described below:

1. Enum-Wakeup      Request to the Host device for polling so that the Peripheral device can perform the operations required for the Enumeration with the Host.  
(Polling ... Host device will give "Response Permission" to the Peripheral device.)
2. Enum-Hailing      Host to perform Hailing so that the Host device can obtain information from the Peripheral devices for Enumeration.
3. Enum-Request      Peripheral to request Enumeration with the Host device once the Peripheral device already obtained the specific Host device information (Host ID, Host specific information).
4. Enum-Response      Host to inform the Peripheral device that the Enumeration with the Peripheral device is completed by Enum-Response.

The peripheral control information that can be obtained by the Sniffer log at the Enumeration sequence generally appears as follows:

Enum-Wakeup(P→H) Enum-Hailing(H→P) Enum-Request(P→H) Enum-Response(H→P)

Following is an example of the actual information transaction between the Host and the Peripheral in its procedure order. Explanation for each procedure is also provided on the right side, enclosed by the box:

\*\*\*\* IrDA-Control Sniffer Version 1.02 (1998/06/09) \*\*\*\*

Fri Sep 04 17:11:40 1998

12 packets received (crcerr:0, frmerr:0, ovrerr:0)

#0 Time:5,603.083ms-5,603.616ms(Gap:5603083us) Short Packet

Host Address:            00  
Peripheral Address:      f Enum-Wakeup  
Mac control:            4 P->H, PollingRequest  
Length: 3  
MAC frame:    00 4f df

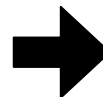

Peripheral device to give Enum-Wakeup to the Host device

#1 Time:5,624.670ms-5,625.630ms(Gap:21054us) Short Packet

Host Address:            12  
Peripheral Address:      f Enum-Hailing HostID=CA61,HInfo=0001  
Mac control:            9 H->P, Hailing  
Length: 7  
MAC frame:    12 9f 61 ca 01 00 56

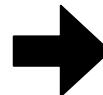

Upon the receipt of the Polling request from the Peripheral device, the Host device (HostID: CA61) will give Enum-Hailing so that Enum-Request can be received.

--- (CONTINUE TO THE NEXT PAGE) ---

#2 Time:5,628.203ms-5,629.163ms(Gap:2573us) Short Packet

Host Address: 12  
Peripheral Address: f Enum-Hailing HostID=CA61, HInfo=0001  
Mac control: 9 H->P, Hailing  
Length: 7  
MAC frame: 12 9f 61 ca 01 00 56

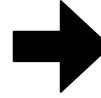

(#2 same as #1)  
the Host device (HostID: CA61) will continue giving Enum-Hailing so that Enum-Request can be received.

( • Snipped • )

#10 Time:5,684.243ms-5,685.629ms(Gap:180us) Short Packet

Host Address: 12  
Peripheral Address: f Enum-Request PFID=A31810F1, PInfo=0001,HostID=CA61  
Mac control: 4 P->H, PollingRequest  
Length: 11  
MAC frame: 12 4f f1 10 18 a3 01 00 61 ca 51

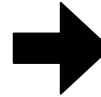

The Peripheral device (PFID = A31810F1) that received the Enum-Hailing will send Enum-Request to the Host device.

#11 Time:5,699.903ms-5,700.863ms(Gap:14274us) Short Packet

Host Address: 12  
Peripheral Address: f Enum-Response PFID=A31810F1  
Mac control: 8 H->P  
Length: 7  
MAC frame: 12 8f f1 10 18 a3 5d

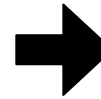

The Host will then give Enum-Response to the Peripheral device to inform of the Enumeration completion.

Above log can generally be obtained from the Sniffer log at the Enumeration sequence. The example of USB-Enum sequence is provided in the next example.

**(Example 2: USB-Enum)**

The USB-Enum sequence is to provide the Peripheral device's Descriptor information to the Host device between the Host and the Peripheral.

Binding procedure will take place between the Host and the Peripheral at the USB-Enum sequence. The Bind sequence is the same as the Enumeration sequence, in which the obtained peripheral control information generally appears as follows:

Bind-Wakeup(P→H) Bind-Hailing(H→P) Bind-Request(P→H) Bind-Response(H→P)

[ Each control information for Bind (Bind-Wakeup, Bind-Hailing, Bind-Request, and Bind-Response) are all corresponding to the control information described in the Enumeration sequence.]

Following is an example of the actual information transaction between the Host and the Peripheral in this sequence order. Explanation for each procedure is also provided on the right side, enclosed by the box:

\*\*\*\* IrDA-Control Sniffer Version 1.02 (1998/06/09) \*\*\*\*  
Mon Sep 21 17:41:39 1998  
1157 packets received (crcerr:0, frmerr:0, ovrerr:0)

#0 Time:2,142.877ms-2,143.623ms(Gap:2142877us) Short Packet  
Host Address: 28  
Peripheral Address: 0 Bind-Wakeup HostID=1CE1  
Mac control: 4 P->H, PollingRequest  
Length: 5  
MAC frame: 28 40 e1 1c b4

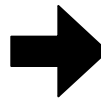

Enumeration between the Host and the Peripheral now completed. The Peripheral then gives Bind-Wakeup to the Host.

#1 Time:2,165.200ms-2,165.946ms(Gap:21577us) Short Packet  
Host Address: 28  
Peripheral Address: 0 Bind-Hailing HostID=1CE1  
Mac control: 9 H->P, Hailing  
Length: 5  
MAC frame: 28 90 e1 1c 37

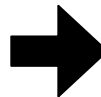

The Host (HostID: 1CE1) received the Polling request from the Peripheral the gives the Bind-Hailing in order to receive the Bind-Request.

#2 Time:2,166.115ms-2,167.075ms(Gap:169us) Short Packet  
Host Address: 28  
Peripheral Address: 0 Bind-Request PFID=8F932776  
Mac control: 4 P->H, PollingRequest  
Length: 7  
MAC frame: 28 40 76 27 93 8f cd

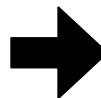

The Peripheral (PFID = 8F932776) gives the Bind-Request to the Host that has sent the Bind-Hailing.

#3 Time:2,181.860ms-2,182.926ms(Gap:14785us) Short Packet  
Host Address: 28  
Peripheral Address: 0 Bind-Response PFID=8F932776,PADD=01  
Mac control: c H->P, BindTimerRestarted  
Length: 8  
MAC frame: 28 c0 76 27 93 8f 01 67

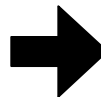

The Host (HostID: 1CE1) will allocate the PADD = 1 to the Peripheral which requested for the Polling, to inform that Binding is now completed.

--- (CONTINUE TO THE NEXT PAGE) ---

#4 Time:2,183.130ms-2,183.663ms(Gap:204us) Short Packet

Host Address: 28  
Peripheral Address: 1  
Mac control: 4 P->H, PollingRequest  
Length: 3  
MAC frame: 28 41 12

#5 Time:2,195.998ms-2,196.744ms(Gap:12335us) Short Packet

Host Address: 28  
Peripheral Address: 1  
Mac control: c H->P, BindTimerRestarted  
Length: 5  
LLC control: 09 EP=0,PT=GET\_DESCRIPTOR(Device)  
MAC frame: 28 c1 09 01 77

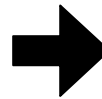

The Host then throws the GET-DESCRIPTOR packet to import the Peripheral Descriptor information to the EP = 0.

#6 Time:2,196.918ms-2,197.558ms(Gap:174us) Short Packet

Host Address: 28  
Peripheral Address: 1  
Mac control: 4 P->H, PollingRequest  
Length: 4  
LLC control: 04 EP=0,PT=ACK  
MAC frame: 28 41 04 20

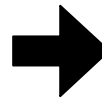

The Peripheral returns ACK packet to confirm the packet given in #5 procedure has been correctly received.

• • Snipped • •

#10 Time:2,223.684ms-2,224.324ms(Gap:11747us) Short Packet

Host Address: 28  
Peripheral Address: 1  
Mac control: 8 H->P  
Length: 4  
LLC control: 08 EP=0,PT=IN  
MAC frame: 28 81 08 19

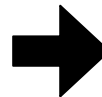

The Host then throws IN packet so that the Descriptor data can be obtained from the Peripheral device at EP = 0.

#11 Time:2,224.516ms-2,226.009ms(Gap:192us) Short Packet

Host Address: 28  
Peripheral Address: 1  
Mac control: 4 P->H, PollingRequest  
Length: 12  
LLC control: 0b EP=0,PT=DATA1  
MAC frame: 28 41 0b 12 01 00 01 00 00 00 08 ee

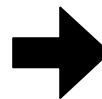

The Peripheral sends DATA1 data packet to the Host.

• • Snipped • •

--- (CONTINUE TO THE NEXT PAGE) ---

#13 Time:2,237.462ms-2,238.102ms(Gap:10245us) Short Packet

Host Address: 28  
Peripheral Address: 1  
Mac control: c H->P, BindTimerRestarted  
Length: 4  
LLC control: 04 EP=0,PT=ACK  
MAC frame: 28 c1 04 c9

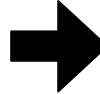

The Host then returns ACK packet to the Peripheral to confirm that the DATA1 packet given in #11 procedure has been correctly received.

#14 Time:2,238.835ms-2,239.581ms(Gap:733us) Short Packet

Host Address: 28  
Peripheral Address: 0 Bind-Hailing HostID=1CE1  
Mac control: 9 H->P, Hailing  
Length: 5  
MAC frame: 28 90 e1 1c 37

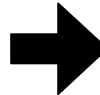

The Host continues to throw Bind-Hailing for a certain period to receive information from other Peripheral devices.

#15 Time:2,264.457ms-2,265.417ms(Gap:24876us) Short Packet

Host Address: 28  
Peripheral Address: f Enum-Hailing HostID=1CE1,HInfo=0001  
Mac control: 9 H->P, Hailing  
Length: 7  
MAC frame: 28 9f e1 1c 01 00 78

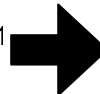

The Host also throws Enum-Hailing when it is in Bind state with the Peripheral device, to observe the existence of other Peripheral devices which needs to be Enumerated.

In the event that the Peripheral device holds many Descriptor information, #10, #11, and #13 log will be repeated. The Host device will also continues sending Bind-Hailing for a certain period after the Polling-Request from the Peripheral. For the meantime, the Host will keep sending Enum-Hailing so that the other Peripheral devices can be enumerated.

Above is a typical log that can be obtained at USB-Enum sequence. A typical log example for the data input/output is also provided in the next example.

**(Example 3: Data Input)**

An example for the typical log at the data input (data input by a keyboard) is provided as shown below:

\*\*\*\* IrDA-Control Sniffer Version 1.02 (1998/06/09) \*\*\*\*

Mon Sep 21 17:42:51 1998

2294 packets received (crcerr:0, frmerr:0, ovrrerr:0)

```
#0 Time:4,364.914ms-4,365.660ms(Gap:4364914us) Short Packet
  Host Address:      28
  Peripheral Address: 0 Bind-Wakeup HostID=1CE1
  Mac control:       4 P->H, PollingRequest
  Length: 5
  MAC frame: 28 40 e1 1c b4

#1 Time:4,387.234ms-4,387.980ms(Gap:21574us) Short Packet
  Host Address:      28
  Peripheral Address 0 Bind-Hailing HostID=1CE1
  Mac control:       9 H->P, Hailing
  Length: 5
  MAC frame: 28 90 e1 1c 37

#2 Time:4,388.143ms-4,389.103ms(Gap:163us) Short Packet
  Host Address:      28
  Peripheral Address: 0 Bind-Request PFID=8F932776
  Mac control:       4 P->H, PollingRequest
  Length: 7
  MAC frame: 28 40 76 27 93 8f cd

#3 Time:4,403.861ms-4,404.927ms(Gap:14758us) Short Packet
  Host Address:      28
  Peripheral Address: 0 Bind-Response PFID=8F932776,PADD=01
  Mac control:       c H->P, BindTimerRestarted
  Length: 8
  MAC frame: 28 c0 76 27 93 8f 01 67

#4 Time:4,405.165ms-4,405.698ms(Gap:238us) Short Packet
  Host Address      28
  Peripheral Address: 1
  Mac control:       4 P->H, PollingRequest
  Length: 3
  MAC frame: 28 41 12

#5 Time:4,418.044ms-4,418.684ms(Gap:12346us) Short Packet
  Host Address:      28
  Peripheral Address 1
  Mac control:       8 H->P
  Length: 4
  LLC control:       28 EP=1,PT=|N
  MAC frame: 28 81 28 c0
```

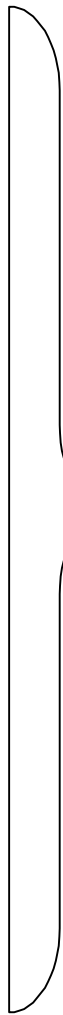

These are the Bind sequence explained in the previous example.

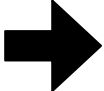

The Host sends IN packet so that the data can be received at EP = 1 from the Peripheral device.

--- (CONTINUE TO THE NEXT PAGE) ---

#6 Time:4,418.883ms-4,420.376ms(Gap:199us) Short Packet

Host Address: 28  
Peripheral Address: 1  
Mac control: 4 P->H, PollingRequest  
Length: 12  
LLC control: 23 EP=1,PT=DATA0  
MAC frame: 28 41 23 00 00 04 00 00 00 00 00 5c

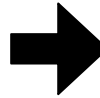

The Peripheral sends DATA0 data packet to the Host. (Information that the key is stroked.)

• • Snipped • •

#8 Time:4,431.822ms-4,432.462ms(Gap:10243us) Short Packet

Host Address: 28  
Peripheral Address: 1  
Mac control: c H->P, BindTimerRestarted  
Length: 4  
LLC control: 24 EP=1,PT=ACK  
MAC frame: 28 c1 24 10

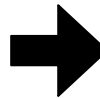

The Host returns ACK packet to confirm the receipt of the packet data (DATA0).

• • Snipped • •

#10 Time:4,445.637ms-4,446.277ms(Gap:11696us) Short Packet

Host Address: 28  
Peripheral Address: 1  
Mac control: 8 H->P  
Length: 4  
LLC control: 28 EP=1,PT=IN  
MAC frame: 28 81 28 c0

#11 Time:4,446.469ms-4,447.962ms(Gap:192us) Short Packet

Host Address: 28  
Peripheral Address: 1  
Mac control: 4 P->H, PollingRequest  
Length: 12  
LLC control: 2b EP=1,PT=DATA1  
MAC frame: 28 41 2b 00 00 00 00 00 00 00 00 3c

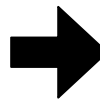

The Peripheral sends DATA1 data packet to the Host. (Information that the key is released.)

• • Snipped • •

#13 Time:4,459.471ms-4,460.111ms(Gap:10300us) Short Packet

Host Address: 28  
Peripheral Address: 1  
Mac control: c H->P, BindTimerRestarted  
Length: 4  
LLC control: 24 EP=1,PT=ACK  
MAC frame: 28 c1 24 10

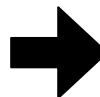

The Host returns ACK packet to confirm the receipt of the packet data (DATA1).

The data from the Peripheral to the Host is as #5, #6, and #8, and the data from the Host to the Peripheral is as #10, #11, and #13, where the Host sends the IN packet data to the Peripheral in order to receive the data. The Peripheral that received the IN packet from the Host then sends data to the Host, from which ACK packet would be returned, for its receipt confirmation. In the event that the Peripheral does not send any data for a certain period, this Peripheral device will shift to the Unbound state, where the Bind sequence is re-required for the data transmission.



## LIFE SUPPORT POLICY

SHARP components should not be used in medical devices with life support functions or in safety equipment (or similar applications where component failure would result in loss of life or physical harm) without the written approval of an officer of the SHARP Corporation.

## LIMITED WARRANTY

SHARP warrants to its Customer that the Products will be free from defects in material and workmanship under normal use and service for a period of one year from the date of invoice. Customer's exclusive remedy for breach of this warranty is that SHARP will either (i) repair or replace, at its option, any Product which fails during the warranty period because of such defect (if Customer promptly reported the failure to SHARP in writing) or, (ii) if SHARP is unable to repair or replace, refund the purchase price of the Product upon its return to SHARP. This warranty does not apply to any Product which has been subjected to misuse, abnormal service or handling, or which has been altered or modified in design or construction, or which has been serviced or repaired by anyone other than Sharp. The warranties set forth herein are in lieu of, and exclusive of, all other warranties, express or implied. ALL EXPRESS AND IMPLIED WARRANTIES, INCLUDING THE WARRANTIES OF MERCHANTABILITY, FITNESS FOR USE AND FITNESS FOR A PARTICULAR PURPOSE, ARE SPECIFICALLY EXCLUDED. In no event will Sharp be liable, or in any way responsible, for any incidental or consequential economic or property damage.

The above warranty is also extended to Customers of Sharp authorized distributors with the following exception: reports of failures of Products during the warranty period and return of Products that were purchased from an authorized distributor must be made through the distributor. In case Sharp is unable to repair or replace such Products, refunds will be issued to the distributor in the amount of distributor cost.

SHARP reserves the right to make changes in specifications at any time and without notice. SHARP does not assume any responsibility for the use of any circuitry described; no circuit patent licenses are implied.

---

# SHARP®

## NORTH AMERICA

SHARP Microelectronics  
of the Americas  
5700 NW Pacific Rim Blvd., M/S 20  
Camas, WA 98607, U.S.A.  
Phone: (360) 834-2500  
Telex: 49608472 (SHARPCAM)  
Facsimile: (360) 834-8903  
<http://www.sharpsma.com>

## EUROPE

SHARP Electronics (Europe) GmbH  
Microelectronics Division  
Sonninstraße 3  
20097 Hamburg, Germany  
Phone: (49) 40 2376-2286  
Telex: 2161867 (HEEG D)  
Facsimile: (49) 40 2376-2232

## ASIA

SHARP Corporation  
Integrated Circuits Group  
2613-1 Ichinomoto-Cho  
Tenri-City, Nara, 632, Japan  
Phone: (07436) 5-1321  
Telex: LABOMETA-B J63428  
Facsimile: (07436) 5-1532